



Contents

Features	2
General Description	2
BB 22 Application Information	3
BB 22 Specifications	4
Designator Drawing	5
Block Diagram	6
Schematic	7
Sound System Interconnection	8
Warranty	24



Recycle cardboard and paper.



Cartons et papier à recycler.



Features

- 2 Channels of -10 dBV (RCA) to +4 dBu (XLR) Conversion
- Nickel Core “80” Ni Transformers — Wide Bandwidth and Low Distortion
- +24 dBu Maximum Levels

General Description

The Rane BB 22 Balance Buddy is a handy professional-grade tool used to provide isolation for and convert unbalanced -10 dBV consumer level RCA outputs up to balanced +4 dBu professional XLR inputs. The BB 22 converts one pair from -10 dBV to +4 dBu. There are two male XLR connectors and two RCA jacks.

Unbalanced lines should always be kept *under* 10 feet (3 meters) to prevent undesirable effects such as hum and noise. The BB 22 allows conversion to balanced lines that can be run across a studio or a house without loss of signal quality. For instance, a BB 22 may be mounted to the back of a jukebox converting its unbalanced outputs to balanced lines, feeding an amplifier in another room.

Signal-to-noise performance is perfectly preserved using the BB 22, since it uses only passive transformers to convert signal levels. It adds no additional noise whatsoever. Use of professional quality nickel core (“80” Ni) transformers guarantee low distortion, wide bandwidth and high signal level handling capability.

The BB 22’s isolation transformers provide a quick and affordable answer to most jobs requiring signal level conversion and output balancing.

WEAR PARTS: This product contains no wear parts.

BB 22 Application Information

Conversion Ratio

The casual observer would think to convert -10 dBV to +4 dBu, you would need 14 dB of gain. The casual observer would be wrong. You only need 12 dB of gain. The reason is not only do you change levels, you also change *reference levels*—from dBV to dBu. The first (dBV) references everything to 1.0 volt, while the second (dBu) references everything to 0.775 volts (this comes from the old *power* reference of 0 dBm, which equaled 1mW into 600 Ω , which equaled .775 volts).

Driving Impedances

Some people wrongly feel you cannot use a transformer to convert between -10 dBV and +4 dBu because of low impedances. This is not a problem as long as you use them to interconnect equipment with *at least 15k ohms input impedance*. Since most professional products have input impedances of 20 k Ω or greater (50k and 100 k Ω are not uncommon), this should never be difficult. A 15 k Ω load winds up looking like 1 k Ω to the equipment with the -10 dBV output (due to transformer action). This may seem excessively low, but is not in practice. The maximum transformer output level of +24 dBu occurs with an input level of +10 dBV, which equals 3.16 volts. And 3.16 volts driving 1 k Ω only requires 3.16 milliamps, which is a very modest requirement for any -10 dBV equipment to deliver.

Wiring

The BB 22 follows AES/ANSI/IEC standards of pin 2 positive and pin 3 negative. Note the shields (commons) of the RCA jacks are not tied together. This provides better ground isolation of the unbalanced units. A positive signal applied to the tip of the RCA jack causes a positive signal to appear on pin 2 of the XLR, and vice-versa if signal direction is reversed.

Signal Direction

Signal can be converted through the channels either direction. The only problem arises in the gender of the XLR connector. The solution requires same-sex XLR adaptors or special cables.

WARNING: This product may contain chemicals known to the State of California to cause cancer, or birth defects or other reproductive harm.

BB 22 Specifications

Parameter	Specification	Limit	Units	Conditions/Comments
Transformer Construction	Nickel Core Bobbin Wound			
Turns Ratio	1:3.89			Grade "80" Ni -10 dBV (316 mV); +4 dBu (1.23 V)
Maximum Levels				
.....-10 dBV In	+10 (40 Hz-20 kHz); +4.5 (20 Hz)	0.5dB	dBV	1% THD point
.....+4 dBu Out	+24 (40 Hz-20 kHz); +18.5 (20 Hz)	0.5dB	dBu	1% THD point
Input Impedance	(Load Impedances as Shown)			
.....-10 dBV	1k	5 %	Ω	Load impedance 15k Ω
Insertion Loss	0.5	0.1	dB	With recommended load impedance
DC Resistance	47.5 / 200	10%	Ω	-10 dBV / +4 dBu
Frequency Response	20-20 kHz	±2	dB	+4 dBu out; recom. load impedance
THD + Noise	less than .05 (40 Hz-20 kHz)	max	%	+4 dBu out
Unit: Conformity	CE, FCC			Exempt
Unit: Construction	All Steel			
.....Size	1.65"H x 5.1"W x 4.25"D			(4.2 cm x 13 cm x 10.8 cm)
.....Weight	1 lb			(.45 kg)
Shipping: Size	3.6" x 11.75" x 7.2"			(9.5 cm x 30 cm x 18 cm)
.....Weight	2 lb			(.9 kg)
All specifications apply both directions, unless noted.				

Designator Drawing

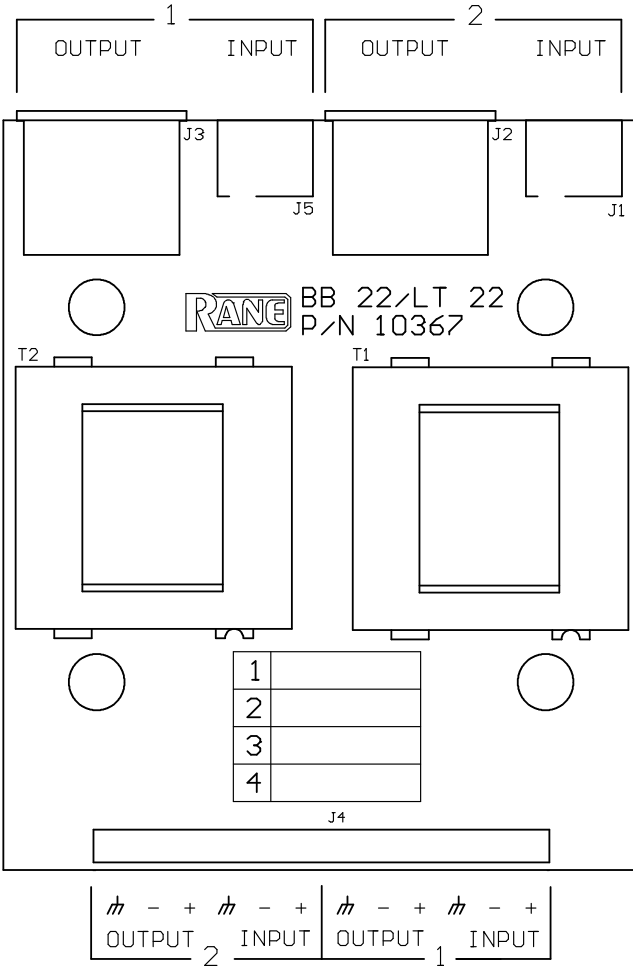

Rane Corp. (425)355-6000
 102687 DES: BB 22/LT 22 SHEET 1 OF 2
 ACTION: NEW PRODUCT FJ 09APR99

Block Diagram

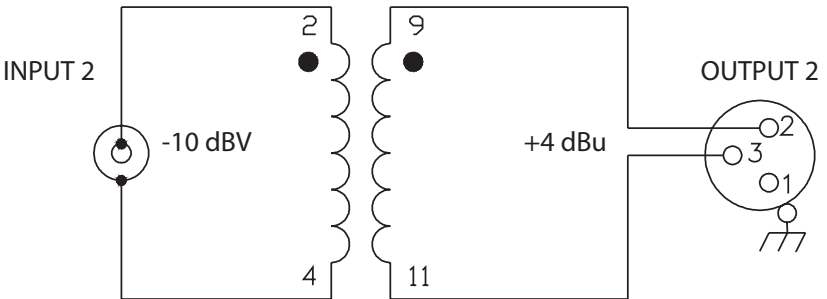
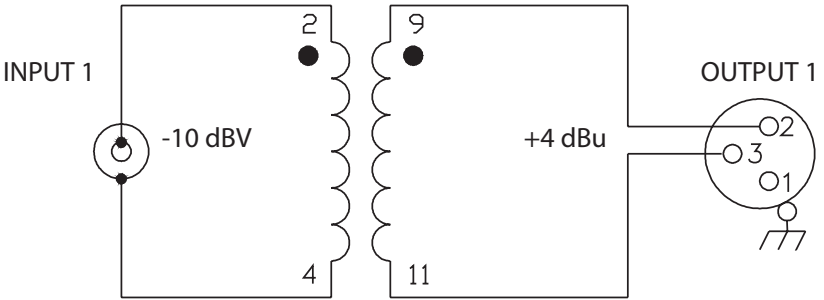

Schematic

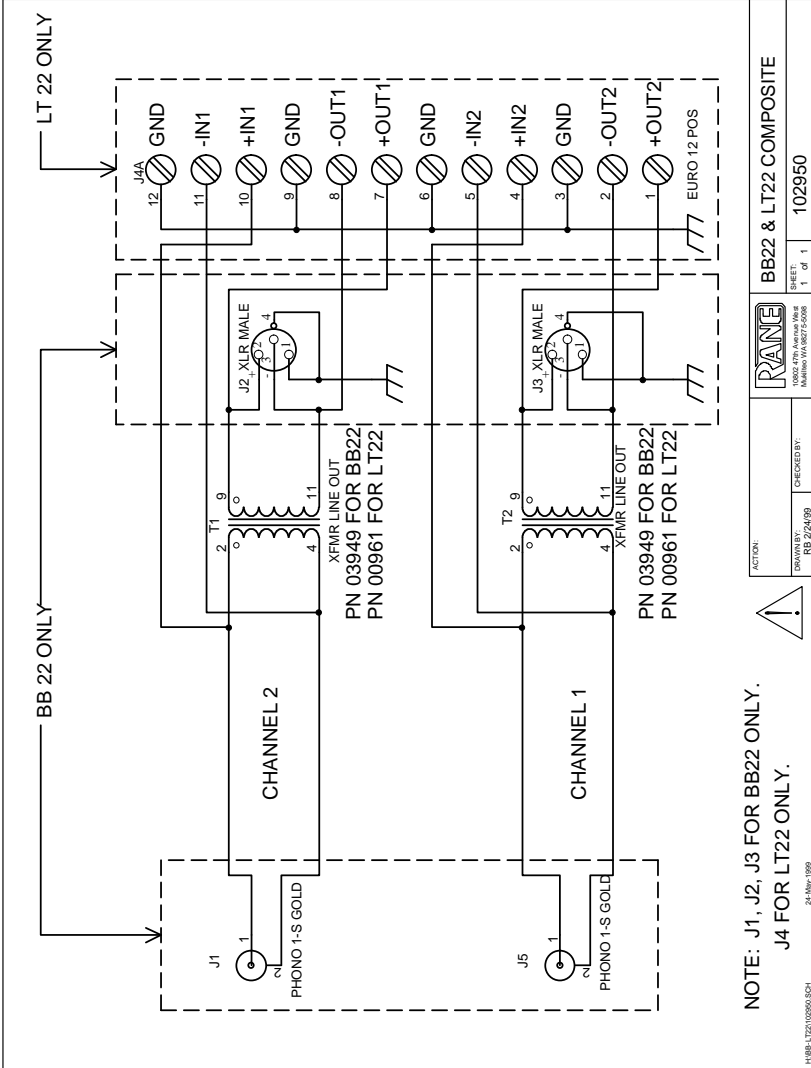

NOTE: J1, J2, J3 FOR BB22 ONLY.
J4 FOR LT22 ONLY.



ACTION:			
DRAWN BY: RJD/24/09		CHECKED BY:	
PART NO: 102950		REV: 1	
DATE: 10/24/09		REV: 1	
DESCRIPTION: BB22 & LT22 COMPOSITE		REV: 1	
PART NO: 102950		REV: 1	

14188-102950-001.SCH

JL 4/09/09

102950

REV: 1

REV: 1

REV: 1

REV: 1

REV: 1

REV: 1



Sound System Interconnection

- Cause & prevention of ground loops
- Interfacing balanced & unbalanced
- Proper pin connections and wiring
- Chassis ground vs. signal ground
- Ground lift switches

Rane Technical Staff

RaneNote 110

© 1985, 1995, 2006, 2007 Rane Corporation

Introduction

This note, originally written in 1985, continues to be one of our most useful references. It's popularity stems from the continual and perpetual difficulty of hooking up audio equipment without suffering through all sorts of bizarre noises, hums, buzzes, whistles, etc.— not to mention the extreme financial, physical and psychological price. As technology progresses it is inevitable that electronic equipment and its wiring should be subject to constant improvement. Many things *have* improved in the audio industry since 1985, but unfortunately wiring isn't one of them. However, finally the Audio Engineering Society (AES) has issued a standards document for interconnection of pro audio equipment. It is AES48, titled “*AES48-2005: AES standard on interconnections — Grounding and EMC practices — Shields of connectors in audio equipment containing active circuitry.*”

Rane's policy is to accommodate rather than dictate. However, this document contains suggestions for external wiring changes that should ideally only be implemented by trained technical personnel. Safety regulations require that all original grounding means provided from the factory be left intact for safe operation. No guarantee of responsibility for incidental or consequential damages can be provided. *(In other words, don't modify cables, or try your own version of grounding unless you really understand exactly what type of output and input you have to connect.)*

Ground Loops

Almost all cases of noise can be traced directly to ground loops, grounding or lack thereof. It is important to understand the mechanism that causes grounding noise in order to effectively eliminate it. Each component of a sound system produces its own ground internally. This ground is usually called the audio *signal* ground. Connecting devices together with the interconnecting cables can tie the signal grounds of the two units together in one place through the conductors in the cable. Ground loops occur when the grounds of the two units are also tied together in another place: via the third wire in the line cord, by tying the metal chassis together through the rack rails, etc. These situations create a circuit through which current may flow in a closed “loop” from one unit’s ground out to a second unit and back to the first. It is not simply the presence of this current that creates the hum—it is when this current flows through a unit’s audio signal ground that creates the hum. In fact, even without a ground loop, a little noise current always flows through every interconnecting cable (i.e., it is impossible to eliminate these currents entirely). The mere presence of this ground loop current is no cause for alarm if your system uses properly implemented and *completely* balanced interconnects, which are excellent at rejecting ground loop and other noise currents. Balanced interconnect was developed to be immune to these noise currents, which can never be entirely eliminated. What makes a ground loop current annoying is when the audio signal is affected. Unfortunately, many manufacturers of balanced audio equipment design the internal grounding system improperly, thus creating balanced equipment that is not immune to the cabling’s noise currents. This is one reason for the bad reputation sometimes given to balanced interconnect.

A second reason for balanced interconnect’s bad reputation comes from those who think connecting unbalanced equipment into “superior” balanced equipment should improve things. Sorry. Balanced interconnect is not compatible with unbalanced. The small physical nature and short cable runs of completely unbalanced systems (home audio) also contain these ground loop noise currents. However, the currents in unbalanced systems never get large enough to affect the audio to the point where it is a nuisance. Mixing balanced and unbalanced equipment, however, is an entirely different story, since balanced and unbalanced interconnect are truly *not compatible*. The rest of this note shows several recommended implementations for all of these interconnection schemes.

The potential or voltage which pushes these noise currents through the circuit is developed between the independent grounds of the two or more units in the system. The impedance of this circuit is low, and even though the voltage is low, the current is high, thanks to Mr. Ohm, without whose help we wouldn’t have these problems. It would take a very high resolution ohm meter to measure the impedance of the steel chassis or the rack rails. We’re talking thousandths of an ohm. So trying to measure this stuff won’t necessarily help you. We just thought we’d warn you.

The Absolute Best Right Way To Do It

The method specified by AES48 is to use balanced lines and *tie the cable shield to the metal chassis (right where it enters the chassis) at both ends of the cable.*

A balanced line requires three separate conductors, two of which are signal (+ and -) and one shield (see Figure 1a). The shield serves to guard the sensitive audio lines from interference. Only by using balanced line interconnects can you *guarantee* (yes, *guarantee*) hum-free results. Always use twisted pair cable. Chassis tying the shield at each end also *guarantees* the best possible protection from RFI [radio frequency interference] and other noises [neon signs, lighting dimmers].

Neil Muncy¹, an electroacoustic consultant and seasoned veteran of years of successful system design, chairs the AES Standards Committee (SC-05-05) working on this subject. He tirelessly tours the world giving seminars and dispensing information on how to successfully hook-up pro audio equipment². He makes the simple point that it is absurd that you cannot go out and buy pro audio equipment from several different manufacturers, buy standard off-the-shelf cable assemblies, come home, hook it all up and have it work hum and noise free. *Plug and play*. Sadly, almost never is this the case, despite the science and rules of noise-free interconnect known and documented for over 60 years (see References for complete information).

It all boils down to using balanced lines, only balanced lines, and nothing but balanced lines. This is why they were developed. Further, that you *tie the shield to the chassis, at the point it enters the chassis, and at both ends of the cable* (more on 'both ends' later).

Since standard XLR cables come with their shields tied to pin 1 at each end (the shells are not tied, nor need be), this means equipment using 3-pin, XLR-type connectors *must tie pin 1 to the chassis* (usually called chassis ground) — not the audio signal ground as is most common.

Not using *signal ground* is the most radical departure from common pro-audio practice. Not that there is any argument about its validity. There isn't. **This is the right way to do it.** So why doesn't audio equipment come wired this way? Well, some does, and since 1993, more of it does. That's when Rane started manufacturing some of its products with balanced inputs and outputs tying pin 1 to chassis. So why doesn't everyone do it this way? Because life is messy, some things are hard to change, and there will always be equipment in use that was made before proper grounding practices were in effect.

Unbalanced equipment is another problem: it is everywhere, easily available and inexpensive. All those RCA and ¼" TS connectors found on consumer equipment; effect-loops and insert-points on consoles; signal processing boxes; digital and analog tape recorders; computer cards; mixing consoles; et cetera.

The next several pages give tips on how to successfully address hooking up unbalanced equipment. Unbalanced equipment when "blindly" connected with fully balanced units starts a pattern of hum and undesirable operation, requiring extra measures to correct the situation.

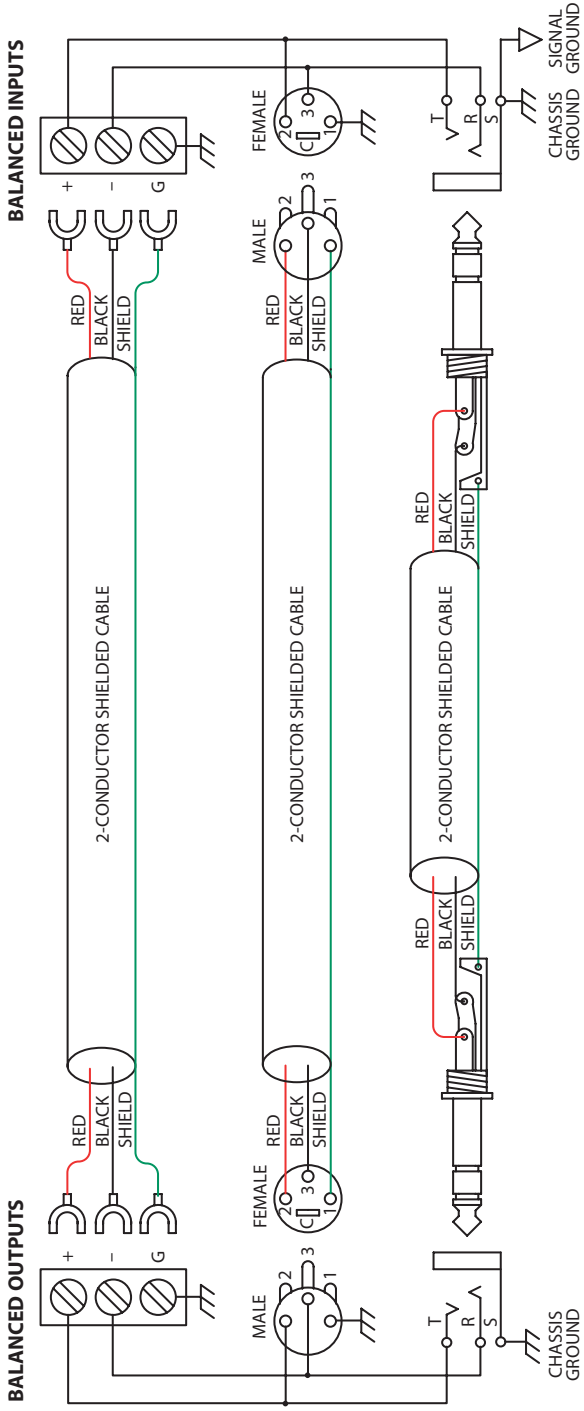
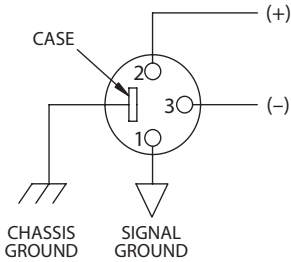

Figure 1a. The right way to do it.

COMMON (WRONG) PRACTICE



RECOMMENDED PRACTICE

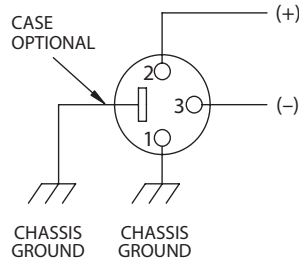

Figure 1b. Recommended practice.

The Next Best Right Way To Do It

The quickest, quietest and most foolproof method to connect balanced and unbalanced is to **transformer isolate all unbalanced connections**. See Figure 2.

Many manufacturers provide several tools for this task, including Rane. Consult your audio dealer to explore the options available.

The goal of these adaptors is to allow the use of *standard cables*. With these transformer isolation boxes, modification of cable assemblies is unnecessary. Virtually any two pieces of audio equipment can be successfully interfaced without risk of unwanted hum and noise.

Another way to create the necessary isolation is to use a *direct box*. Originally named for its use to convert the high impedance, high level output of an electric guitar to the low impedance, low level input of a recording console, it allowed the player to plug “directly” into the console. Now this term is commonly used to describe any box used to convert unbalanced lines to balanced lines.

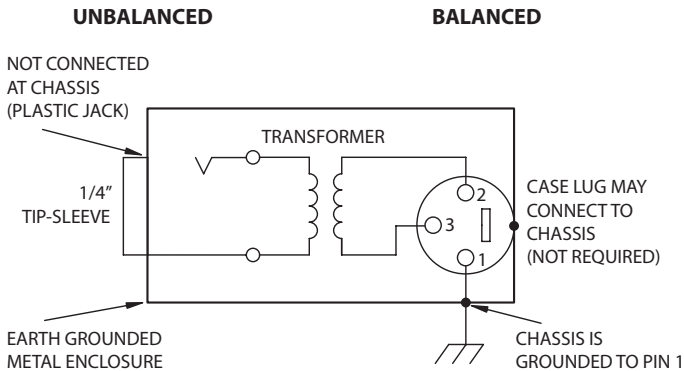

Figure 2. Transformer Isolation

The Last Best Right Way To Do It

If transformer isolation is not an option, special cable assemblies are a last resort. The key here is to prevent the shield currents from flowing into a unit whose grounding scheme creates ground loops (hum) in the audio path (i.e., most audio equipment).

It is true that connecting both ends of the shield is theoretically the best way to interconnect equipment –though this assumes the interconnected equipment is internally grounded properly. Since most equipment is *not* internally grounded properly, connecting both ends of the shield is not often practiced, since doing so usually creates noisy interconnections.

A common solution to these noisy hum and buzz problems involves disconnecting one end of the shield, even though one can not buy off-the-shelf cables with the shield disconnected at one end. The best end to disconnect is the receiving end. If one end of the shield is disconnected, the noisy hum current stops flowing and away goes the hum — but only at low frequencies. A ground-sending-end-only shield connection minimizes the possibility of high frequency (radio) interference since it prevents the shield from acting as an antenna to the next input. Many reduce this potential RF interference by providing an RF path through a small capacitor (0.1 or 0.01 microfarad ceramic disc) connected from the lifted end of the shield to the chassis. (This is referred to as the “hybrid shield termination” where the sending end is bonded to the chassis and the receiving end is capacitively coupled. See Neutrik’s EMC-XLR for example.) The fact that many modern day installers still follow this one-end-only rule with consistent success indicates this and other acceptable solutions to RF issues exist, though the increasing use of digital and wireless technology greatly increases the possibility of future RF problems.

If you’ve truly isolated your hum problem to a specific unit, chances are, even though the documentation indicates proper chassis grounded shields, the suspect unit is not internally grounded properly. Here is where special test cable assemblies, shown in Figure 3, really come in handy. These assemblies allow you to connect the shield to chassis ground *at the point of entry*, or to pin 1, or to lift one end of the shield. The task becomes more difficult when the unit you’ve isolated has multiple inputs and outputs. On a suspect unit with multiple cables, try various configurations on each connection to find out if special cable assemblies are needed at more than one point.

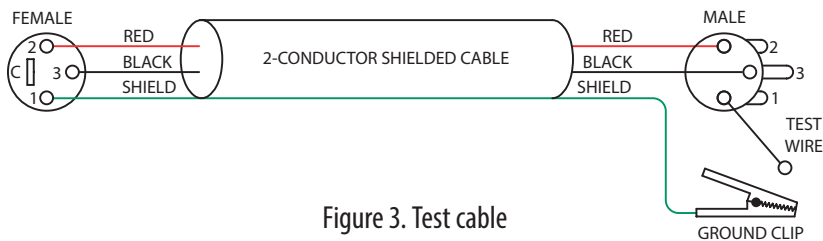

Figure 3. Test cable

See Figure 4 for suggested cable assemblies for your particular interconnection needs. Find the appropriate output configuration (down the left side) and then match this with the correct input configuration (across the top of the page.) Then refer to the following pages for a recommended wiring diagram.

Ground Lifts

Many units come equipped with ground lift switches. In only a few cases can it be shown that a ground lift switch improves ground related noise. (Has a ground lift switch ever *really* worked for you?) In reality, the presence of a ground lift switch greatly reduces a unit's ability to be "properly" grounded and therefore immune to ground loop hums and buzzes. Ground lifts are simply another Band-Aid[®] to try in case of grounding problems. It is true that an entire system of properly grounded equipment, without ground lift switches, is guaranteed (yes *guaranteed*) to be hum free. The problem is most equipment is *not* (both internally and externally, AC system wise) grounded properly.

Most units with ground lifts are shipped so the unit is "grounded" — meaning the chassis is connected to audio signal ground. (This should be the best and is the "safest" position for a ground lift switch.) If after hooking up your system it exhibits excessive hum or buzzing, there is an incompatibility somewhere in the system's grounding configuration. In addition to these special cable assemblies that may help, here are some more things to try:

1. Try combinations of lifting grounds on units supplied with lift switches (or links). It is wise to do this with the power off!
2. If you have an entirely balanced system, verify all chassis are tied to a good earth ground, for safety's sake and hum protection. Completely unbalanced systems never earth ground anything (except cable TV, often a ground loop source). If you have a mixed balanced and unbalanced system, do yourself a favor and use isolation transformers or, if you can't do that, try the special cable assemblies described here and expect it to take many hours to get things quiet. May the Force be with you.
3. Balanced units with outboard power supplies (wall warts or "bumps" in the line cord) do *not* ground the chassis through the line cord. Make sure such units are solidly grounded by tying the chassis to an earth ground using a star washer for a reliable contact. (Rane always provides this chassis point as an external screw with a toothed washer.) Any device with a 3-prong AC plug, such as an amplifier, may serve as an earth ground point. Rack rails may or may not serve this purpose depending on screw locations and paint jobs.

Floating, Pseudo, and Quasi-Balancing

During inspection, you may run across a ¼" output called floating unbalanced, sometimes also called pseudo-balanced or quasi-balanced. In this configuration, the sleeve of the output stage is not connected inside the unit and the ring is connected (usually through a small resistor) to the audio signal ground. This allows the tip and ring to “appear” as an equal impedance, not quite balanced output stage, even though the output circuitry is unbalanced.

Floating unbalanced often works to drive either a balanced or unbalanced input, depending if a TS or TRS standard cable is plugged into it. When it hums, a special cable is required. See drawings #11 and #12, and do not make the cross-coupled modification of tying the ring and sleeve together.

Winning the Wiring Wars

- Use balanced connections whenever possible, with the shield bonded to the metal chassis at both ends.
- Transformer isolate all unbalanced connections from balanced connections.
- Use special cable assemblies when unbalanced lines cannot be transformer isolated.
- Any unbalanced cable must be kept under 10 feet (3 m) in length. Lengths longer than this will amplify all the nasty side effects of unbalanced circuitry's ground loops.

Summary

If you are unable to do things correctly (i.e. use fully balanced wiring with shields tied to the *chassis* at both ends, or transformer isolate all unbalanced signals from balanced signals) then there is no guarantee that a hum-free interconnect can be achieved, nor is there a definite scheme that will assure noise-free operation in all configurations.

References

1. Neil A. Muncy, "Noise Susceptibility in Analog and Digital Signal Processing Systems," presented at the 97th AES Convention of Audio Engineering Society in San Francisco, CA, Nov. 1994.
 2. *Grounding, Shielding, and Interconnections in Analog & Digital Signal Processing Systems: Understanding the Basics*; Workshops designed and presented by Neil Muncy and Cal Perkins, at the 97th AES Convention of Audio Engineering Society in San Francisco, CA, Nov. 1994.
 3. The entire June 1995 AES Journal, Vol. 43, No. 6, available \$6 members, \$11 nonmembers from the Audio Engineering Society, 60 E. 42nd St., New York, NY, 10165-2520.
 4. Phillip Giddings, *Audio System Design and Installation* (SAMS, Indiana, 1990).
 5. Ralph Morrison, *Noise and Other Interfering Signals* (Wiley, New York, 1992).
 6. Henry W. Ott, *Noise Reduction Techniques in Electronic Systems*, 2nd Edition (Wiley, New York, 1988).
 7. Cal Perkins, "Measurement Techniques for Debugging Electronic Systems and Their Instrumentation," *The Proceedings of the 11th International AES Conference: Audio Test & Measurement*, Portland, OR, May 1992, pp. 82-92 (Audio Engineering Society, New York, 1992).
 8. Macatee, *RaneNote*: "Grounding and Shielding Audio Devices," Rane Corporation, 1994.
 9. Philip Giddings, "Grounding and Shielding for Sound and Video," *S&VC*, Sept. 20th, 1995.
 10. AES48-2005: *AES standard on interconnections — Grounding and EMC practices — Shields of connectors in audio equipment containing active circuitry* (Audio Engineering Society, New York, 2005).
- Band-Aid is a registered trademark of Johnson & Johnson*









Figures 4a, 4b, 4c.

Interconnect chart for locating correct cable assemblies on the following pages.

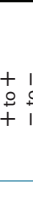
Note: (A) This configuration uses an "off-the-shelf" cable.





Note: (B) This configuration causes a 6 dB signal loss. Compensate by "turning the system up" 6 dB.

To Input

CABLE CONNECTORS  FEMALE BALANCED XLR (NOT A TRANSFORMER, NOR A CROSS-COUPLED OUTPUT STAGE)	 MALE BALANCED XLR	 1/4" BALANCED TRS (TIP-RING-SLEEVE)	 1/4" OR 3.5mm UNBALANCED TS (TIP-SLEEVE)	 UNBALANCED RCA	 BALANCED EUROBLOCK
 FEMALE BALANCED XLR (NOT A TRANSFORMER, NOR A CROSS-COUPLED OUTPUT STAGE)	1	2	3^B	4^B	+ to + - to - SHIELD NC
 FEMALE BALANCED XLR (EITHER A TRANSFORMER OR A CROSS-COUPLED OUTPUT STAGE)	1	2	5	6	+ to + - to - SHIELD NC
 1/4" BALANCED TRS (NOT A TRANSFORMER, NOR A CROSS-COUPLED OUTPUT STAGE)	7	8	9^B	10^B	+ to + - to - SHIELD ONLY TO EUROBLOCK
 1/4" BALANCED TRS (EITHER A TRANSFORMER OR A CROSS-COUPLED OUTPUT STAGE)	7	8	11	12	+ to + - to - SHIELD NC

From Output

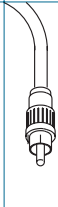
To Input

 <p>1/4" BALANCED TRS (EITHER A TRANSFORMER OR A CROSS-COUPLED OUTPUT STAGE)</p>	<p>7</p>	<p>8</p>	<p>11</p>	<p>12</p>	<p>+ to + - to - SHIELD NC</p>
 <p>1/4" FLOATING UNBALANCED TRS (TIP-RING-SLEEVE) (SLEEVE IN UNIT = NC)</p>	<p>21^A</p>	<p>22^A</p>	<p>11</p>	<p>12</p>	<p>+ to + - to - GROUND TO GROUND</p>
 <p>1/4" OR 3.5 mm UNBALANCED TS (TIP-SLEEVE)</p>	<p>13</p>	<p>14</p>	<p>15^A</p>	<p>16^A</p>	<p>23</p>
 <p>UNBALANCED RCA (TIP-SLEEVE)</p>	<p>17</p>	<p>18</p>	<p>19^A</p>	<p>20^A</p>	<p>23</p>
 <p>BALANCED EUROBLOCK</p>	<p>+ to + - to - SHIELD ONLY TO XLR PIN 1</p>	<p>+ to + - to - SHIELD ONLY TO TRS SLEEVE</p>	<p>24</p>	<p>24</p>	<p>+ to + - to - GROUND TO GROUND</p>

From Output



To Input

From Output

To Input



From Output

To Input



From Output

To Input

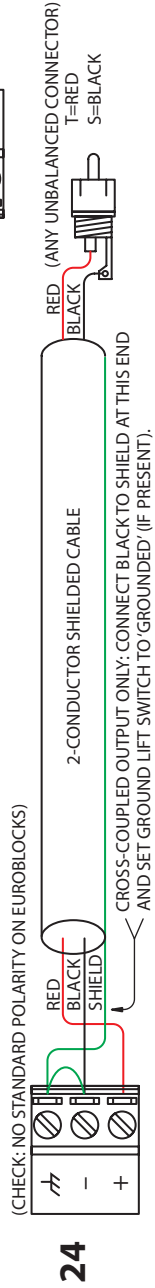
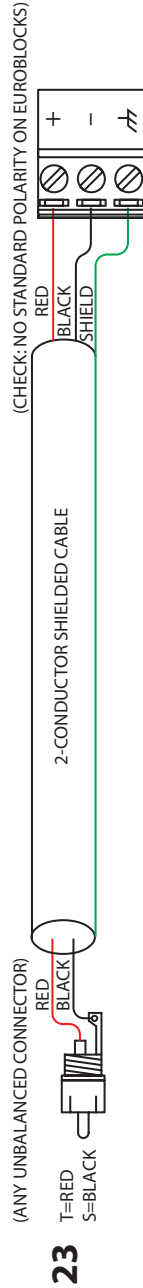

From Output



Factory Authorized Service

Your unit may be serviced by the Rane Factory or any Authorized Rane Service Center. To find a Service Center near you, please call the Rane factory, or check the Rane website. Please do not return your unit to Rane without prior authorization.

Rane Corporation

To obtain service or a Return Authorization, please phone 425-355-6000
or Fax 425-347-7757

The current list of U.S. Rane Authorized Service Centers is on our website:

www.rane.com/service.html

Limited Domestic Warranty

RANE CORPORATION WARRANTS ALL RANE PRODUCTS (EXCEPT THOSE ITEMS CLASSIFIED AS *WEAR PARTS*, AND LISTED ON THE MANUAL-1 PAGE OF EACH OPERATORS MANUAL) PURCHASED IN THE U.S. AGAINST DEFECTS IN MATERIAL OR WORKMANSHIP FOR A PERIOD OF TWO (2) YEARS. *WEAR PARTS* ARE LIMITED TO A PERIOD OF NINETY (90) DAYS FROM THE INITIAL DATE OF RETAIL PURCHASE FROM AN AUTHORIZED RANE DEALER—*WEAR PARTS* REQUIRE PROOF OF PURCHASE DATE. This limited warranty extends to all purchasers or owners of the product during the warranty period beginning with the original retail purchase. Rane Corporation does not, however, warrant its products against any and all defects: 1) arising out of material or workmanship not provided or furnished by Rane, or 2) resulting from abnormal use of the product or use in violation of instructions, or 3) in products repaired or serviced by other than authorized Rane repair facilities, or 4) in products with removed or defaced serial numbers, or 5) in components or parts or products expressly warranted by another manufacturer. Rane agrees to supply all parts and labor to repair or replace defects covered by this limited warranty with parts or products of original or improved design, at its option in each respect, if the defective product is shipped prior to the end of the warranty period to any Rane authorized warranty repair facility in the U.S. or to the Rane factory in the original packaging or a replacement supplied by Rane, with all transportation costs and full insurance paid each way by the purchaser or owner.

Limited Warranty Outside the U.S.A.

RANE PRODUCTS ARE WARRANTED ONLY IN THE COUNTRY WHERE PURCHASED, THROUGH THE AUTHORIZED RANE DISTRIBUTOR IN THAT COUNTRY, AGAINST DEFECTS IN MATERIAL OR WORKMANSHIP, THE SPECIFIC PERIOD OF THIS LIMITED WARRANTY SHALL BE THAT WHICH IS DESCRIBED TO THE ORIGINAL RETAIL PURCHASER BY THE AUTHORIZED RANE DEALER OR DISTRIBUTOR AT THE TIME OF PURCHASE. Rane Corporation does not, however, warrant its products against any and all defects: 1) arising out of materials or workmanship not provided or furnished by Rane, or 2) resulting from abnormal use of the product or use in violation of instructions, or 3) in products repaired or serviced by other than authorized Rane repair facilities, or 4) in products with removed or defaced serial numbers, or 5) in components or parts or products expressly warranted by another manufacturer. Rane agrees, through the applicable authorized distributor, to repair or replace defects covered by this limited warranty with parts or products of original or improved design, at its option in each respect, if the defective product is shipped prior to the end of the warranty period to the designated authorized Rane warranty repair facility in the country where purchased, or to the Rane factory in the U.S., in the original packaging or a replacement supplied by Rane, with all transportation costs and full insurance paid each way by the purchaser or owner.

ALL REMEDIES AND THE MEASURE OF DAMAGES ARE LIMITED TO THE ABOVE SERVICES, IT IS POSSIBLE THAT ECONOMIC LOSS OR INJURY TO PERSON OR PROPERTY MAY RESULT FROM THE FAILURE OF THE PRODUCT; HOWEVER, EVEN IF RANE HAS BEEN ADVISED OF THIS POSSIBILITY, THIS LIMITED WARRANTY DOES NOT COVER ANY SUCH CONSEQUENTIAL OR INCIDENTAL DAMAGES. SOME STATES OR COUNTRIES DO NOT ALLOW THE LIMITATIONS OR EXCLUSION OF INCIDENTAL OR CONSEQUENTIAL DAMAGES, SO THE ABOVE LIMITATION MAY NOT APPLY TO YOU.

ANY AND ALL WARRANTIES, EXPRESS OR IMPLIED, ARISING BY LAW, COURSE OF DEALING, COURSE OF PERFORMANCE, USAGE OF TRADE, OR OTHERWISE, INCLUDING BUT NOT LIMITED TO IMPLIED WARRANTIES OF MERCHANTABILITY AND FITNESS FOR A PARTICULAR PURPOSE, ARE LIMITED TO A PERIOD OF TWO (2) YEARS FROM EITHER THE DATE OF ORIGINAL RETAIL PURCHASE OR, IN THE EVENT NO PROOF OF PURCHASE DATE IS AVAILABLE, THE DATE OF MANUFACTURE, SOME STATES OR COUNTRIES DO NOT ALLOW LIMITATIONS ON HOW LONG AN IMPLIED WARRANTY LASTS, SO THE ABOVE LIMITATIONS MAY NOT APPLY TO YOU. THIS LIMITED WARRANTY GIVES YOU SPECIFIC LEGAL RIGHTS, AND YOU MAY ALSO HAVE OTHER RIGHTS WHICH VARY FROM STATE TO STATE, COUNTRY TO COUNTRY.

Warranty Procedure - Valid in USA only

NOTICE! You must complete and return the warranty card or register your product online to extend the Warranty from 2 years to 3 years!

TO VALIDATE YOUR EXTENDED WARRANTY

Use the postcard that came in the box with your unit, or go to www.rane.com and click on **New Product Registration**. Fill out the warranty completely, being sure to include the model and serial number of the unit since this is how warranties are tracked. If your Rane product was purchased in the U.S.A., mail the completed card or register online with to Rane Corporation within 10 days from the date of purchase. **If you purchased the product outside the U.S.A. you must file your warranty registration with the Rane Distributor in that country.** It is advised that you keep your bill of sale as proof of purchase, should any difficulties arise concerning the registration of the warranty card. **NOTICE: It is not necessary to register in order to receive Rane Corporation's standard two-year limited warranty.**

WARRANTY REGISTRATION is made and tracked by **model and serial numbers only**, not by the purchaser's or owner's name. Therefore any warranty correspondence or inquires **must** include the model and serial number of the product in question. Be sure to fill in the model and serial number in the space provided below and keep this in a safe place for future reference.

WARRANTY SERVICE MUST BE PERFORMED ONLY BY AN AUTHORIZED RANE SERVICE FACILITY LOCATED IN THE COUNTRY WHERE THE UNIT WAS PURCHASED, OR (if product was purchased in the U.S.) AT THE RANE FACTORY IN THE USA. If the product is being sent to Rane for repair, please call the factory for a Return Authorization number. We recommend advance notice be given to the repair facility to avoid possible needless shipment in case the problem can be solved over the phone.

UNAUTHORIZED SERVICE PERFORMED ON ANY RANE PRODUCT WILL VOID ITS EXISTING FACTORY WARRANTY.

FACTORY SERVICE

If you wish your Rane product to be serviced at the factory, **it must be shipped fully insured, in the original packing box or equivalent.** This warranty will **not** cover repairs on products damaged through improper packaging. If possible, avoid sending products through the U.S. mail. Be sure to include in the package:

1. Complete return street shipping address (P.O. Box numbers are **not** acceptable).
2. A detailed description of any problems experienced, including the make and model numbers of any other system equipment.
3. Remote power supply, if applicable.

Repaired products purchased in the U.S. will be returned prepaid freight via the same method they were sent to Rane. Products purchased in the U.S., but sent to the factory from outside the U.S. **must** include return freight funds, and the sender is fully responsible for all customs procedures, duties, tariffs and deposits.

In order to qualify for Rane's one year extended warranty (for a total of 3 years parts and labor), the warranty must be completely filled out and sent to us immediately. Valid in the USA only.

We recommend you write your serial number here in your owners manual and on your sales receipt for your records.

SERIAL NUMBER: _____

PURCHASE DATE: _____



BB 22

BALANCE BUDDY

